



INSTALLATION GUIDE AND USER MANUAL OF
SAUNUM CLASSIC MINI

saunum

Contents

1. Installation requirements	3
2. Transport.....	4
3. Protective OSB box disassembling	5
Disassembling steps:.....	5
4. Final assembly	7
Needed tools for the assembly	7
Included assembly materials.....	7
Final Assembly Instructions	8
5. Instructions for adjusting sauna door	11
Adjusting the hinge	11
6. Sauna electrical connections	12
7. User guide	16
Using and connecting Bluetooth speakers	16
Using remote controller.....	16
8. Maintenance	17
General upkeep.....	17
Interior maintenance	17
Exterior care.....	17
General notes.....	17
9. WARRANTY CONDITIONS FOR SAUNUM SAUNAS.....	18
Warranty Period:.....	18
Coverage:	18
Exclusions:.....	19
Claims Process:.....	19
10. Spare parts	20

Saunum

Thank you for purchasing a Saunum outdoor sauna!

1. Installation requirements

The base or foundation for Sauna must be **leveled** and **stable**. Sauna must be at least 3 inches higher from the surrounding ground. All base beams must have a support under them. Weight of the sauna: 2204 lbs.

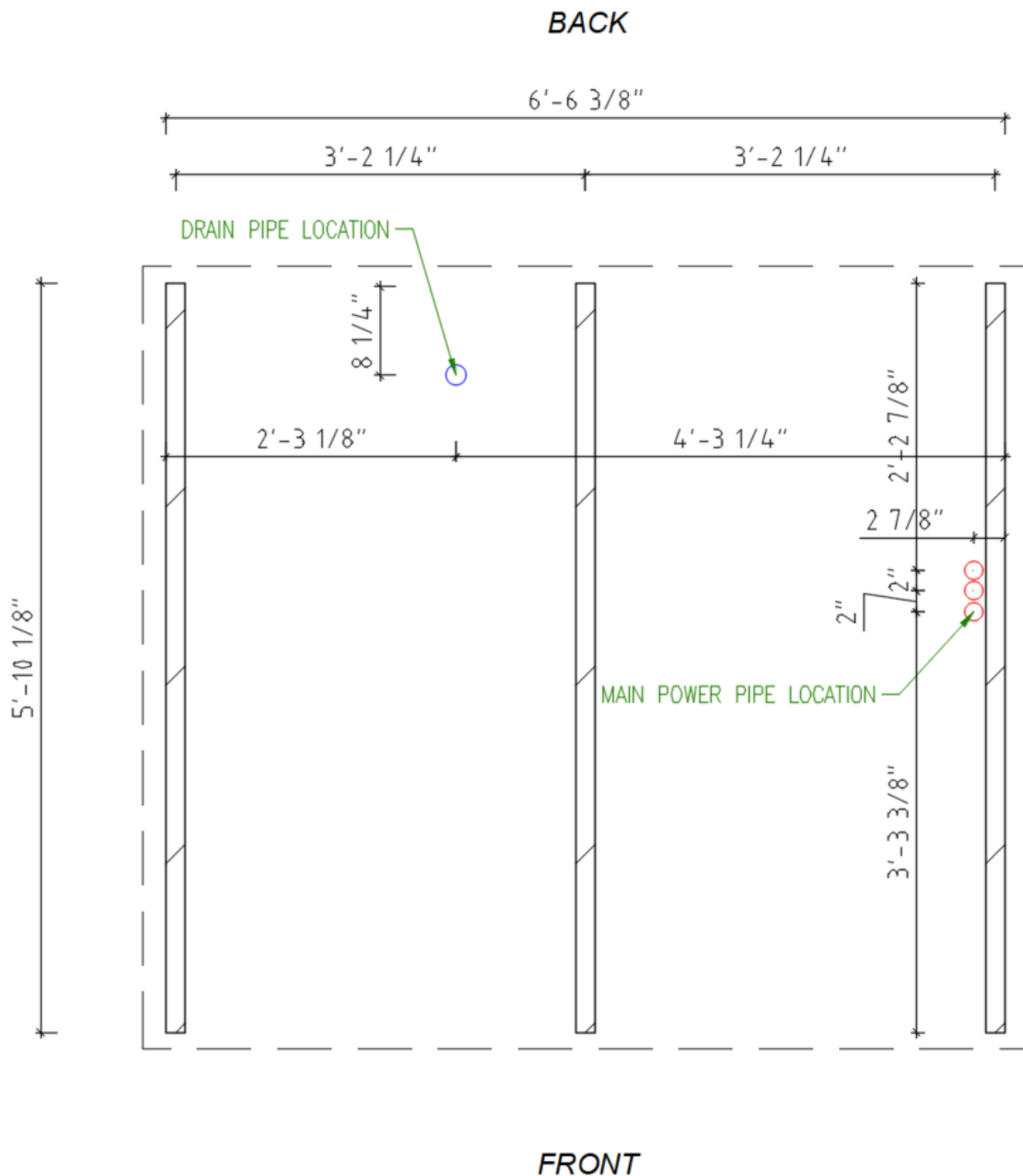

Recommendation:

We recommend placing Sauna on concrete blocks or strips that have a compressed gravel underneath. Using geotextile under the Sauna prevents the growth of grass and weed.

It is also possible to place the Sauna on terrace or pavement, but the Sauna should still be higher than the surface.

saunum

2. Transport

Sauna is packed into protective OSB box. Do not disassemble the OSB box until after lifting the sauna into its final location. Total weight of the sauna with OSB box is 2535 lbs.

Sauna can be lifted from **above with crane**:

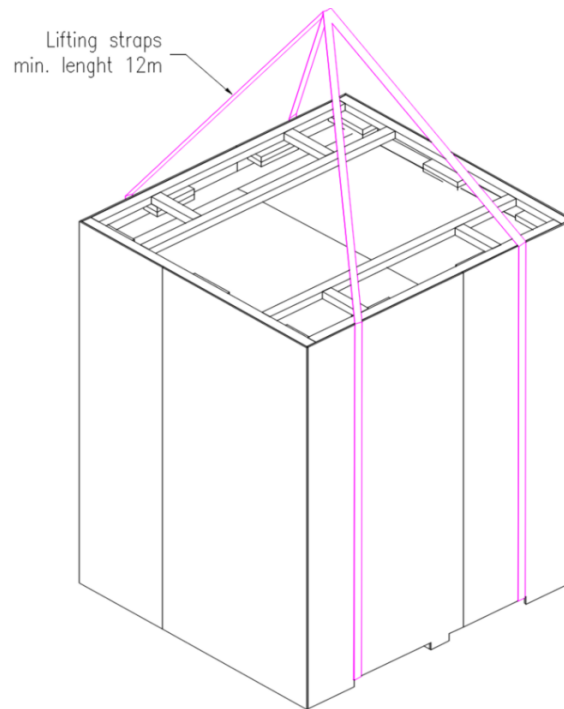

Sauna can be lifted from **below with forklift**:

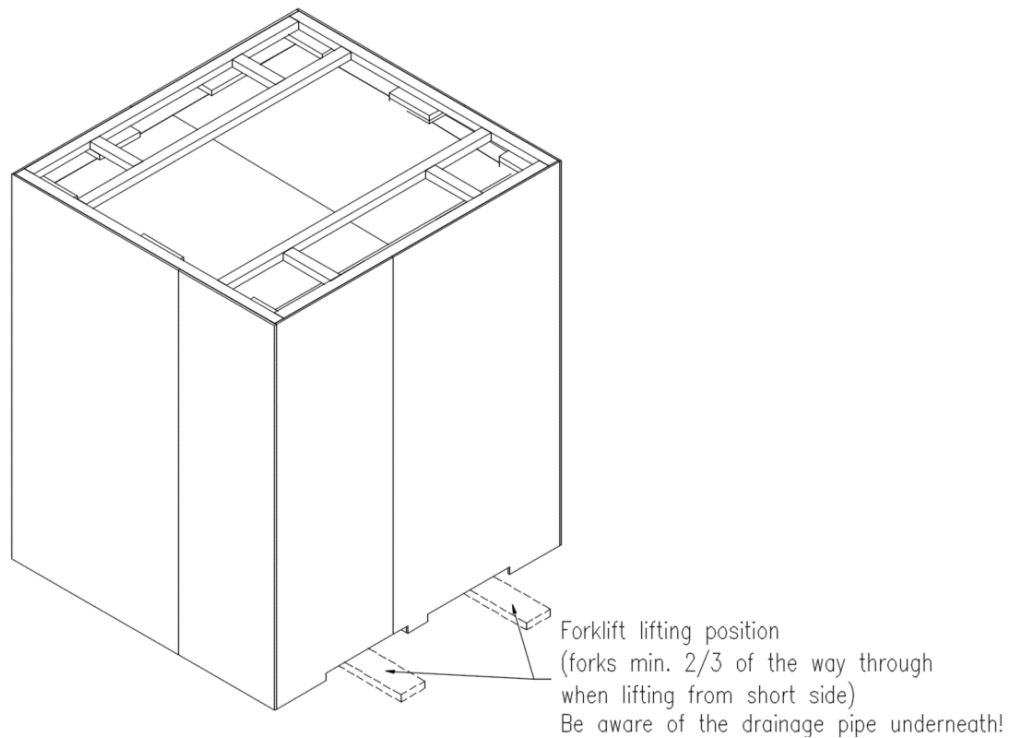

3. Protective OSB box disassembling

Dismantle the protective OSB box before final assembly. OSB boards are fastened with small screws covered with round stickers. The OSB boards, including the screw cover stickers, are painted black. The stickers prevent paint from getting into the screw heads and the screws are much easier to find.

Disassembling steps:

1. Remove stickers from the boards
2. Unscrew the boards with a power screwdriver
3. Remove the OSB boards and stack them on a level surface
4. Make sure that the supports of the boards do not come loose and fall down when loosening the screws

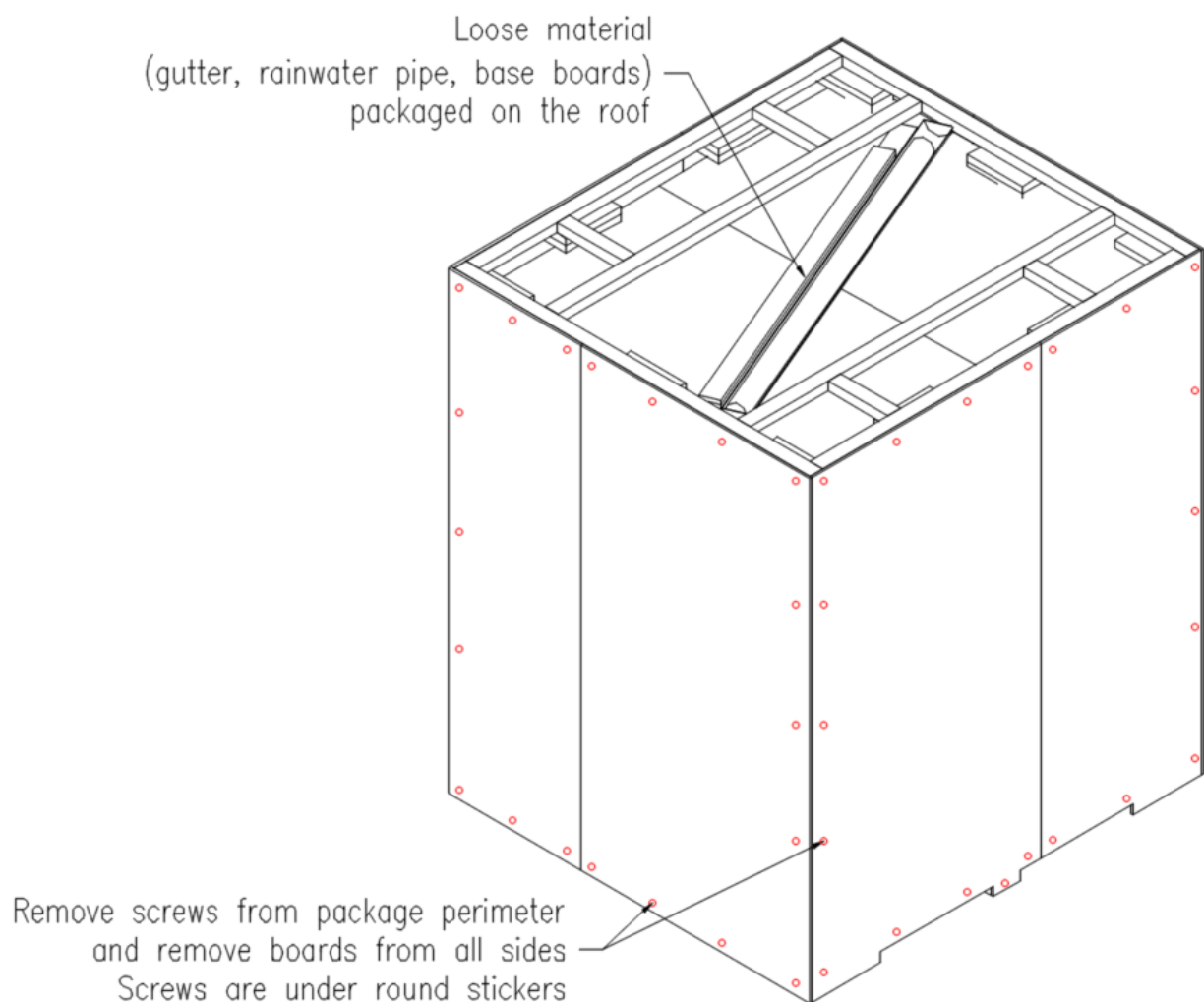

saunum

5. Once all the boards around the sauna have been removed, you can start dismantling the board supports at the top and bottom of the sauna
6. The sauna has a wooden frame at the top, that is not attached to the sauna itself.
7. The lower part of the boards is supported with timber. These are fastened with longer screws
8. Board supports and roof frame taken off; the final assembly process can be started.

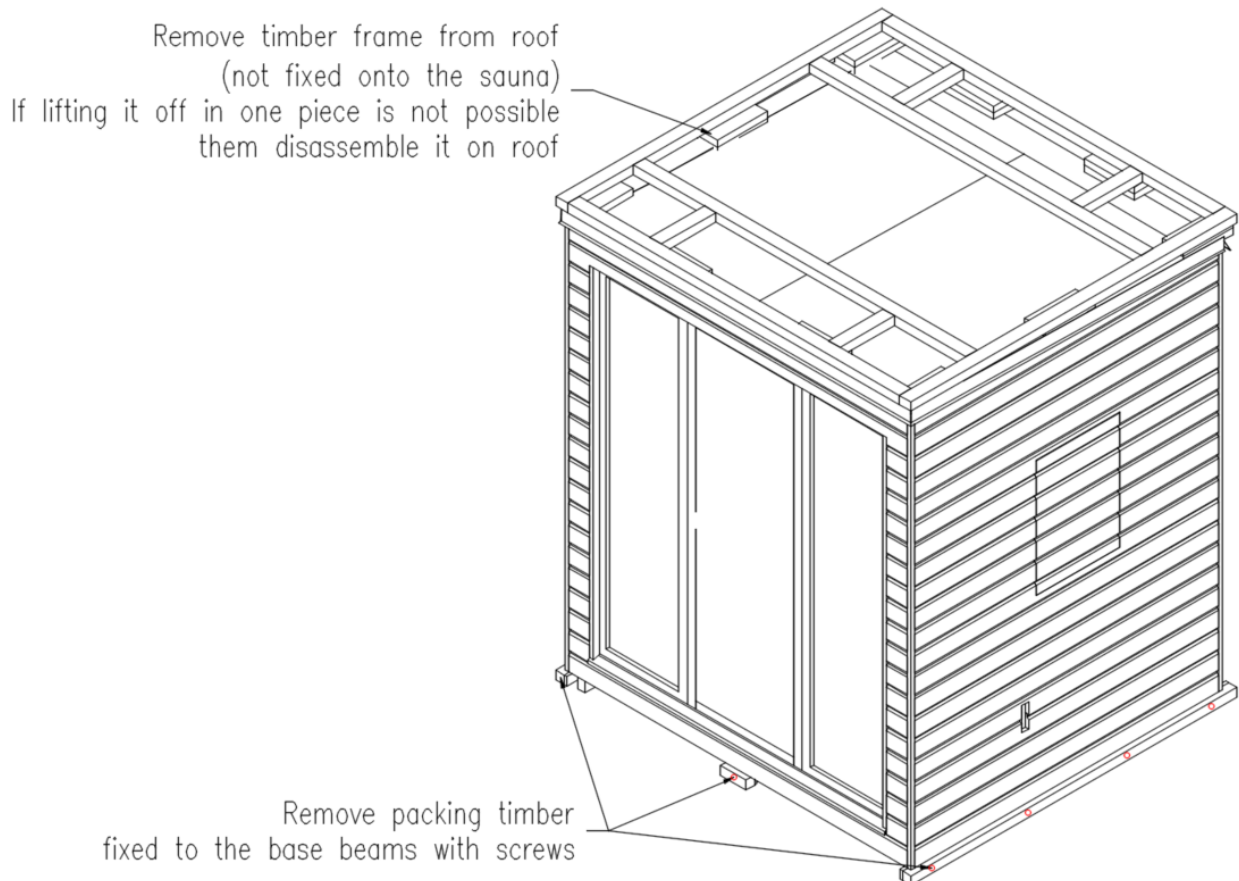

PS!

1. Be aware of the risk of falling objects when unpacking the package
2. Screw markings on drawings are indicative
3. Dispose of packaging material according to local requirements

4. Final assembly

Final assembly shall be organized **by the client**. All electrical connections must be made by certified electrician.

Final assembly includes installing of the:

- Parapet metal;
- Decorative base boards;
- Rainwater system;
- Main power cable;
- Heater (*+ control unit*);
- Outdoor 12V lights.

Sauna door must be adjusted according to the instructions after the final installation, if needed.

Needed tools for the assembly

- Ladder
- Level
- Tape measure
- Drill Driver
- TORX head driver bit set
- 8 mm hex head socket for the driver
- Sheet metal scissors
- Metal cutting saw
- 1/8-inch drill bit for metal
- Rivet gun
- Pliers
- Hex key set
- Screwdriver set
- Sealant gun + weather resistant silicone
- Paint brush
- Circular saw

Included assembly materials

Fixings:

4x50; TX20 woodscrews, black

5x70; TX25 woodscrews

3,2x8 rivet, black, alu.

Exterior finish:

Extra cladding boards, 2 pcs.

Base boards, 4 pcs. (top of the roof)

Repair paint, 400 ml

Rainwater system:

Gutter (top of the roof)

Gutter support bracket, 3 pcs.

Drop outlet

Downpipe (top of the roof)

Downpipe brackets, 2 pcs.

Outlet

saunum

Final Assembly Instructions

Base boards installation

Purpose of the base boards is decorative. Baseboards have been cut in the correct length and have pre-drilled holes in them. When installing the baseboards, make sure you are using the right board on the correct side. Attach each baseboard to the base beams using 4x50mm (black) woodscrews.

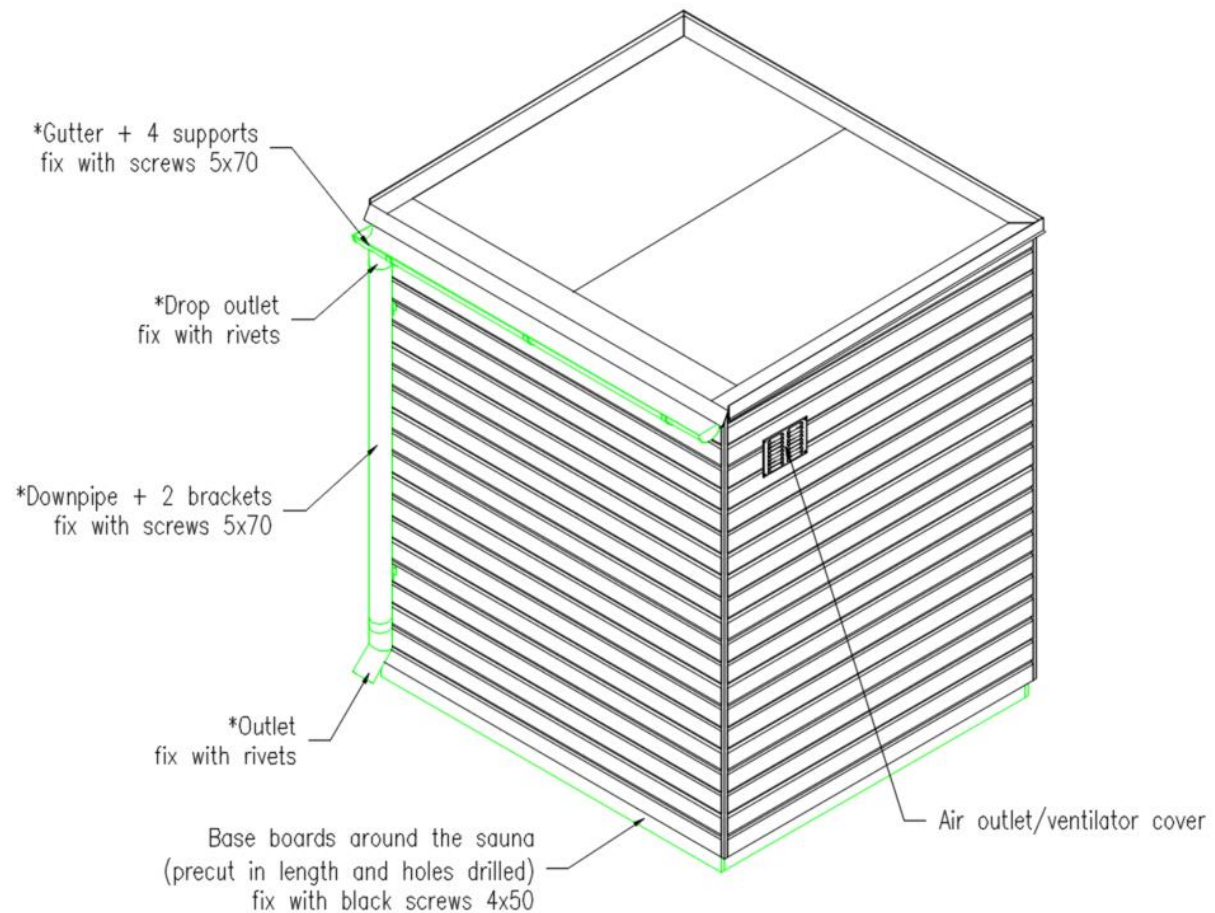

Interior floor grid adjustment

To adjust the floor grid for heater installation, make sure the heater rests directly on the ground and not on the grids. You can achieve this by either cutting a hole in the grids that matches the heater's size or by rotating the grids 90 degrees to allow for a proper fit and maintain effective airflow around the heater

saunum

Rainwater system installation

1. Begin the assembly process by securing gutter brackets to the wall using 5x70 woodscrews, with 2 screws per bracket. Distribute the gaps equally between the five brackets along the length of the gutter.
2. The brackets should be mounted with a slight downward angle towards the drain outlet

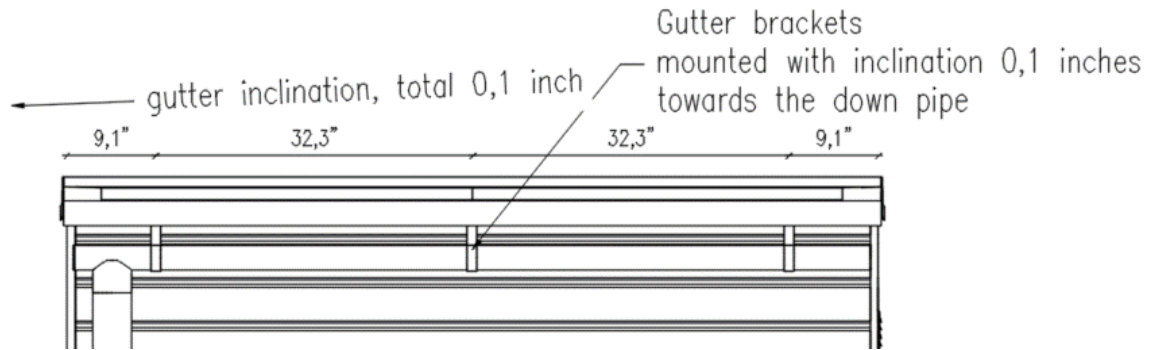

3. Mark the location on the underside of the gutter where you want to attach the downpipe. Using a hacksaw, make an opening in the base of the gutter

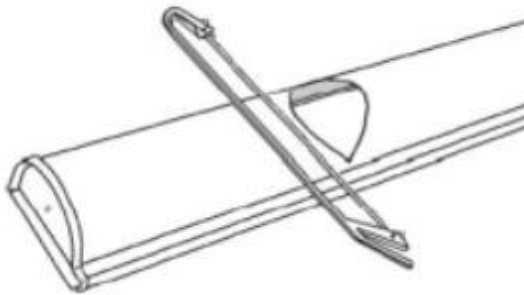

4. Position the gutter on the brackets and push it down until it clicks into place.
5. Place the drop outlet from below over the hole cut in the gutter. Bend the strips of the outlet around the edges of the gutter so the end piece is firmly in place. Use Pliers if necessary

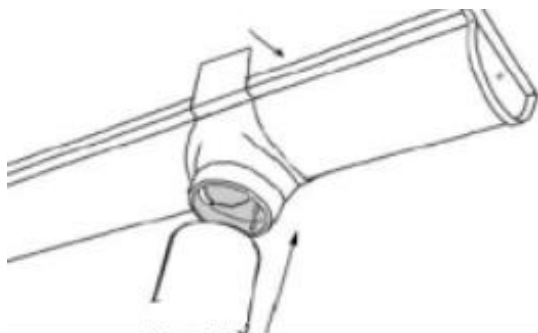

saunum

6. Install downpipe brackets use 5x70 screws two or each on the centerline of the drop outlet. Use 5x70 screws two or each. Brackets are required on both ends of the downpipe - at the connection with the drop outlet and at the elbow outlet.

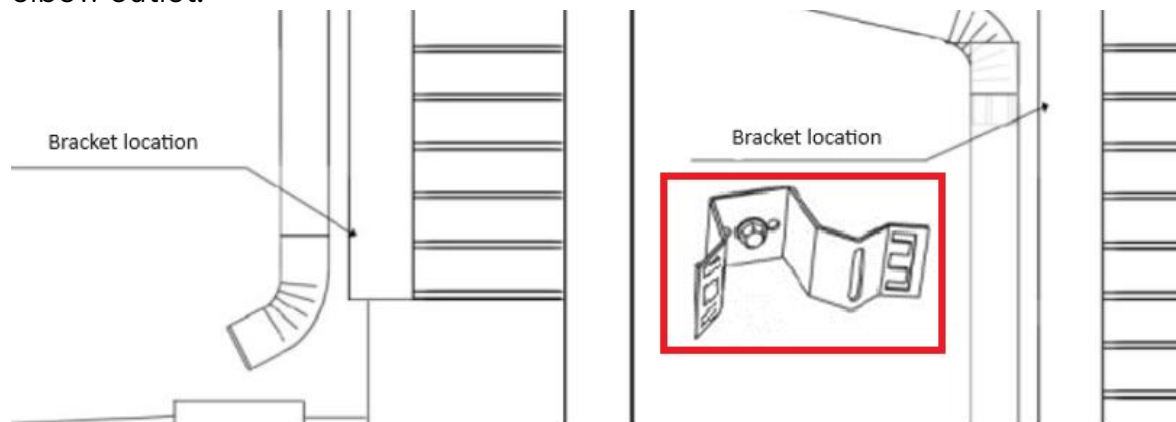

7. Insert the downpipe into drop outlet and fasten the pipe on the wall with brackets

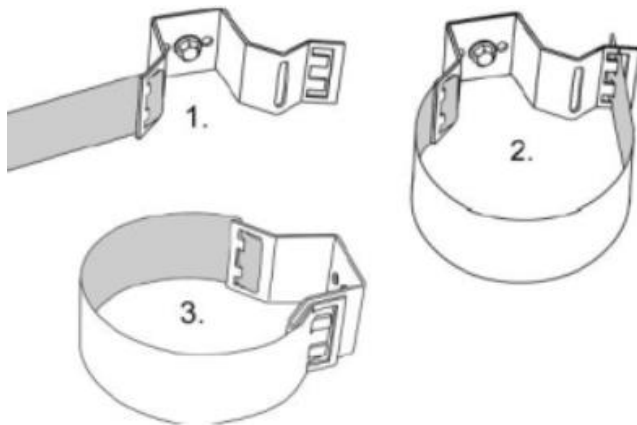

8. Finally use rivets to attach the pipe ends to the outlets.

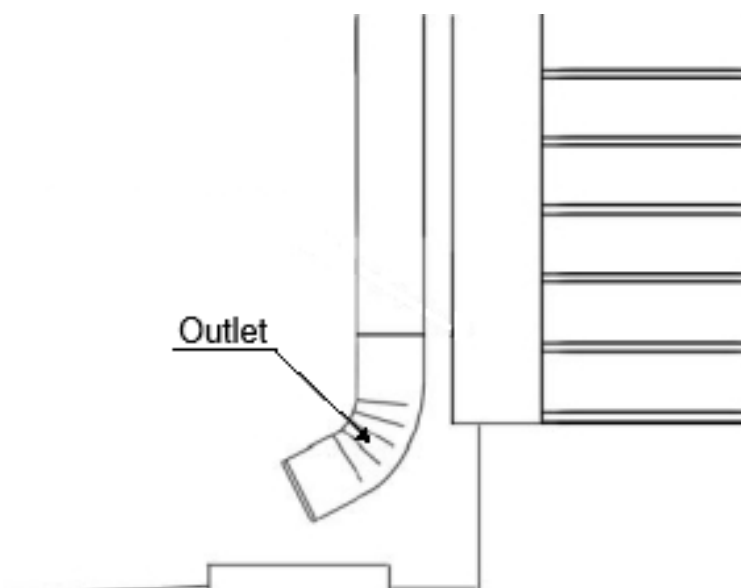

5. Instructions for adjusting sauna door

Adjusting the hinge

1. Remove covers from the hinges from the inside of the sauna to reveal the bolts
2. Unscrew the bolts a bit on both hinges to loosen the door leaf



3. Adjust the door leaf position inside the frame.
4. If gaps between door glass and frame are equal and parallel then tighten the bolts



Place back the hinge cover.

6. Sauna electrical connections

Saunas have been prewired. All electrical connections for LED lights, speakers and ventilator are made in factory (**Figure 1**).

All the electrical connections must be made by certified electrician.

Electrical connections

1. There are two electrical boxes (120 VAC and 240 VAC) located behind wooden door on the side of the sauna. Door can be unlocked with the small key, that is provided with the sauna
2. The top electrical panel 120 VAC is for LED lights and lower one 240 VAC for heater control unit + ventilator. The access doors to the electrical boxes can be opened using a flat head screwdriver.
3. To get to the electrical connections, you need to unscrew the metal covers using a TX20 screwdriver.
4. After you have removed metal covers, you will find distribution terminal blocks, where power supply cables must be connected (**Figure 1, Nr.8**) Powering lights/vent 120V max. 1kW/9A, wires three 16AWG, 600V and for powering heater 240V max. 11kW/46A, four wires 10AWG, 600V. All cables must be external use only.
5. Underneath the sauna, there are three conduit pipes, which are intended to run through power cables for sauna.
6. Cables will enter 240 VAC box through holes in bottom of electrical cabinet (**Figure 2, POWER**). Cabel in 120 VAC box will enter through the side of the cabinet (**Figure 2, POWER**).
7. Wires must be connected to distribution terminal blocks and tightened with the screws. (**Figure 2, Nr.8**)

240 VAC box:	120 VAC box:
• L1 – 120 VAC live wire	• L1 – 120 VAC live wire
• L2 – 120 VAC live wire	• N – neutral wire
• N – neutral wire	• PE – ground wire
• PE – ground wire	
8. 240 VAC electrical cabinet has free space for mounting heater control unit box (**Figure 2, Heater Control Box**). All cables, that need to be connected to control unit are labeled (Heater power, Heater vent, Temp. sensor, Controller, Door sensor). Heater manufacture installation manuals must be followed.
9. Preparations have been made for controller installations inside the sauna. String has been threaded through conduit leading to a 120VAC electrical box (**Figure 2, Controller**). The string and controller cable need to be tied together so that the cable can be pulled through to replace the string. Follow the manufacture installation manual to choose correct cable.
10. Door sensor cable (2x0,75) is preplaced trough door threshold. While mounting heater, the door sensor must be installed. Door sensor must be flush with the door threshold and the magnet need to be glued underneath the door frame.

saunum

11. Inside the wall is rigid pipe, which leads to the 120 VAC electrical box. To install temperature sensor, hole needs to be drilled through heater side of the wall. Drilled hole must be at least 2 inches deep, but not more than 3 inches. Location of the hole is **shown on the drawing below**. Measurement must be taken from the window frame and the ceiling. After the hole is drilled, suitable cable must be pulled through hole and pipe. Follow heater manufacture installation manuals

Pipe location in the wall for temperature sensor
height 2-13 inches from ceiling
Client can drill the hole in the appropriate height
and rurd the wire through

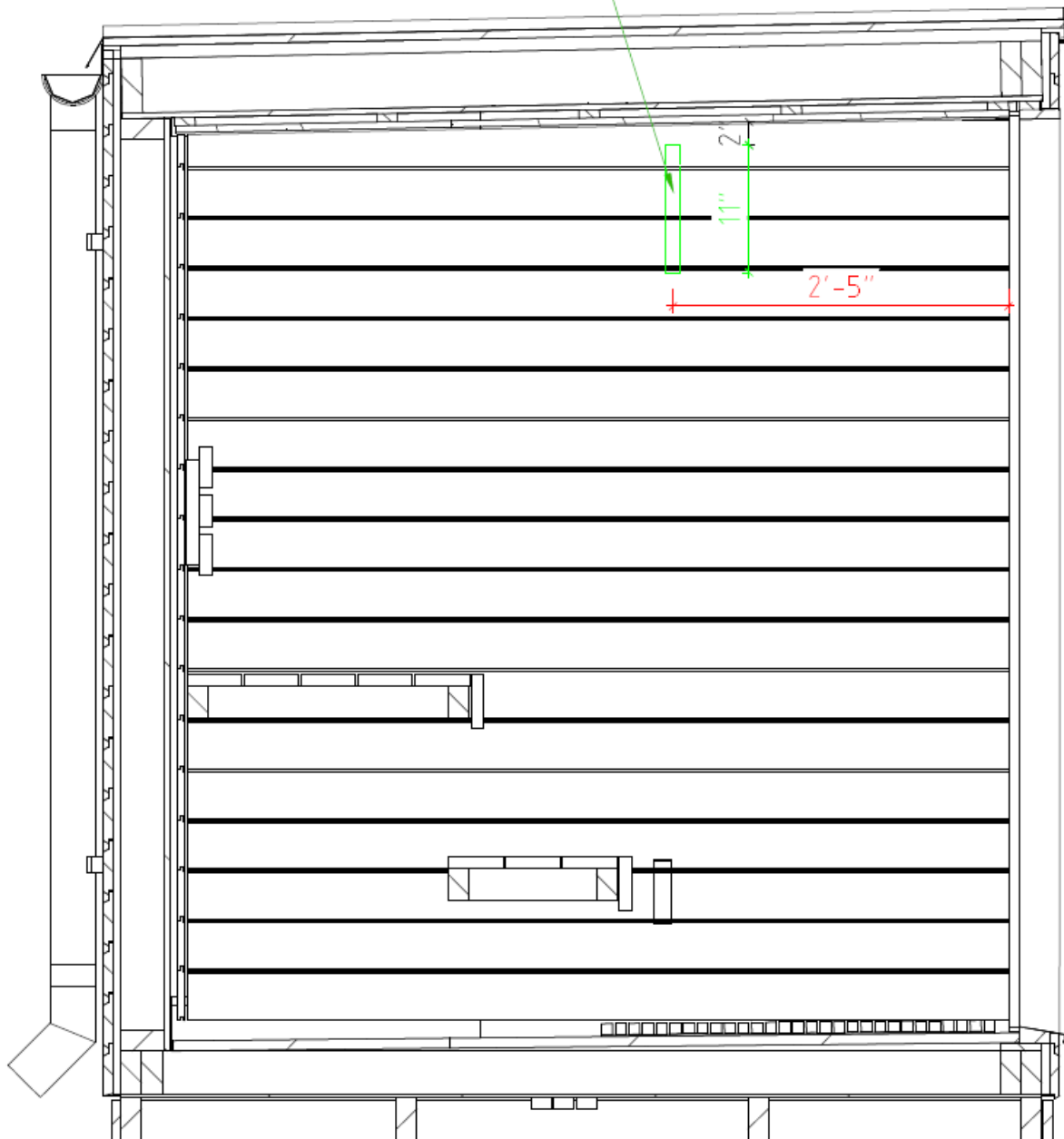

saunum

saunum

7. User guide

Using and connecting Bluetooth speakers

1. Make sure that Sauna is connected to external power
2. There is a red light on the speakers if they are not connected to any device
3. Turn on Bluetooth on your phone and search for available devices
4. "PROMARINE-BT65" should appear on the list
5. Connect your phone with it and speakers should make a sound to indicate a successful connection
6. Now there should be a blue light on the speakers and they are ready to transmit sound

Using remote controller

The remote is used to control Sauna's lights and extraction ventilator:

- Channel 1 – interior lights
- Channel 2 – ventilator



Interior lights (Channel 1) are dimmable when holding down ON or OFF button. Other Channels should be controlled by pressing ON/OFF button once, not holding them down.

8. Maintenance

General upkeep

- After each use, ensure that the sauna is properly ventilated. Turn on the ventilation system to help dry out any excessive moisture.
- Gently clean the surfaces of benches and cladding with a damp cloth to remove any sweat or dirt buildup. Do not use harsh chemicals or abrasives which could damage the wood.

Interior maintenance

- Treat interior wood surfaces with a wood preservative specially formulated for saunas to guard against rot and maintain its resistance to heat and moisture.
- Regularly remove the wooden floor grid and clean underneath. Sweep or vacuum any debris. Clean the wooden floor grid with a damp cloth and a gentle wood cleaner, avoid using excessive water.
- Routinely check corners and crevices for any signs of mold or mildew, treating them promptly if found.

Exterior care

- Clean the exterior cladding once year using special wood cleaner designed for outdoor use to prevent any mold or mildew formation.
- Check for any chipping or peeling on the exterior surface and reapply a protective finish if necessary.

General notes

- Never pour water over the heater when it is off.
- Do not leave combustible materials like towels inside the sauna after use.
- Ensure you read and follow all safety instructions provided by your sauna heater manufacturer regarding operation and maintenance activities.
- For any concerns regarding electrical systems, contact certified electricians for inspection and repair. Regularly conducting these maintenance steps will help prolong the life of your sauna and ensure a safe, enjoyable experience.
- Sauna door must be closed during heating to avoid over-heating!

9. WARRANTY CONDITIONS FOR SAUNUM SAUNAS

Warranty Period:

The warranty is valid for a period of 2 years from the date of purchase.

Warranty is only valid if the sauna's foundation has been constructed correctly according to the guidelines provided. Improperly constructed foundations will void this warranty.

Coverage:

The warranty covers defects in materials and workmanship of the wooden interior, cladding, bench, wooden frame of the sauna. and the roof covering material

Interior Elements: The warranty covers defects in wooden interior cladding and benches, provided the sauna has been used under normal conditions (not for commercial usage) and received proper maintenance as per manufacturer's guidelines. This warranty does not include changes in wood color, texture, or slight warping, which are natural characteristics of wood. Including window frame.

Structural Integrity: The wooden frame of the sauna is warranted against defects in workmanship and materials. This does not include minor cosmetic issues which do not affect the performance of the sauna.

Roof Covering: Protan the roof covering material is warranted against leaks due to material manufacturing and workmanship defects. The mechanical damage on the Roof covering material will not be covered under warranty.

saunum

Exclusions:

This warranty does not cover any damage or defects resulting from normal wear and tear, lack of maintenance as per instructions, alteration, misuse, or abuse. Man-made injuries or damage caused by accidents, pests, natural disasters or any other external forces and transportation damages are specifically excluded from this warranty.

Warranty is only valid if the sauna's foundation has been constructed correctly according to the guidelines provided. Improperly constructed foundations will void this warranty.

Issues arising from failure to perform maintenance as per provided instructions.

Damage to external painted wooden cladding due to lack of maintenance.

Water damage if a rainwater system is not installed or if it is improperly installed.

The heater unit is excluded from this warranty (sold separately).

The warranty is only valid if heater is installed in strict accordance with the manufacturer's instructions. Improper installation will result in voiding of this warranty.

It is crucial to adhere to all safety distances around the sauna heater as per manufacturer requirements. Failure to keep a safe distance can lead to safety hazards and invalidate this warranty.







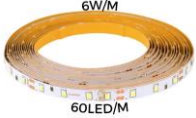

Claims Process:

To file a claim under this warranty, the original purchaser must contact customer service with proof of purchase and detailed description/photos of the defect within the warranty period. The manufacturer reserves the right to inspect the defect before honoring any warranty claim.

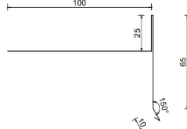
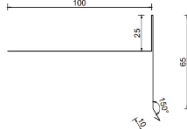
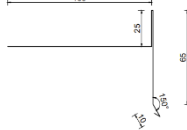
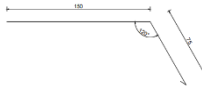
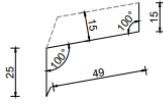







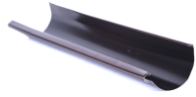

10. Spare parts

Order number	Part Name	Part Picture
9050023	Feed-through terminal block	
9050025	Feed-through terminal block	
9050043	End and partition plate for terminal block	
9050059	Feed-through terminal block	
9050060	Feed-through terminal block	
9050061	End and partition plate for terminal block	
9050063	Cross-connector for terminal block	
9050075	Feed-through terminal block	
9050074	Relay module	
9050062	End bracket for terminal block	
9050045	AC-DC Single output LED driver	
9030010	RF dimmer SR-2501NEA	
9030011	RF dimmer switch	





saunum

Order number	Part Name	Part Picture
2020002	Tangential fan NCA 60-120/23	
9040007	LED STRIP LIGHT	
9050005	Speakers	
4030061	Parapet metal right	
4030062	Parapet metal left	
4030063	Parapet metal front	
4030059	Roof drip metal	
4030060	Window-door metal	
4030004	Rainwater gutter end cap	
4030003	Rainwater gutter bracket	
4030002	Rainwater drop outlet	
4030006	Rainwater down pipe bracket	
4030007	Rainwater outlet	

saunum

Order number	Part Name	Part Picture
4030005	Rainwater down pipe	
4030064	Rainwater gutter	
7060033	Cladding board (1 pc 2,4m)	
7060004	Base board (1 pc 2,8m)	
2020012	Air outlet cover 260x190mm	
2020011	Air inlet cover 140x190mm	
7050038	Cladding board STS3 15x120mm (1 pc 2,7m)	
7070076	Bench board 28x120mm (1 pc 2,7m)	
7070044	Backrest board 28x90mm (1 pc 2,4m)	
7070073	Backrest board 28x65mm (1 pc 2,4m)	
7070071	Skirt board 28x42mm (1 pc 2,4m)	
7070066	Floor grid board 28x28mm (1 pc 2,4m)	
2020008	Air inlet cover	
2020009	Air outlet cover	

saunum

Order number	Part Name	Part Picture
2010003	Trap cover	
5030012	Door hinge	
5030010	Lock cylinder	
5030009	Lock case	
5030011	Door handle	

saunum

